

Viega press systems

Reliable connections for every application.

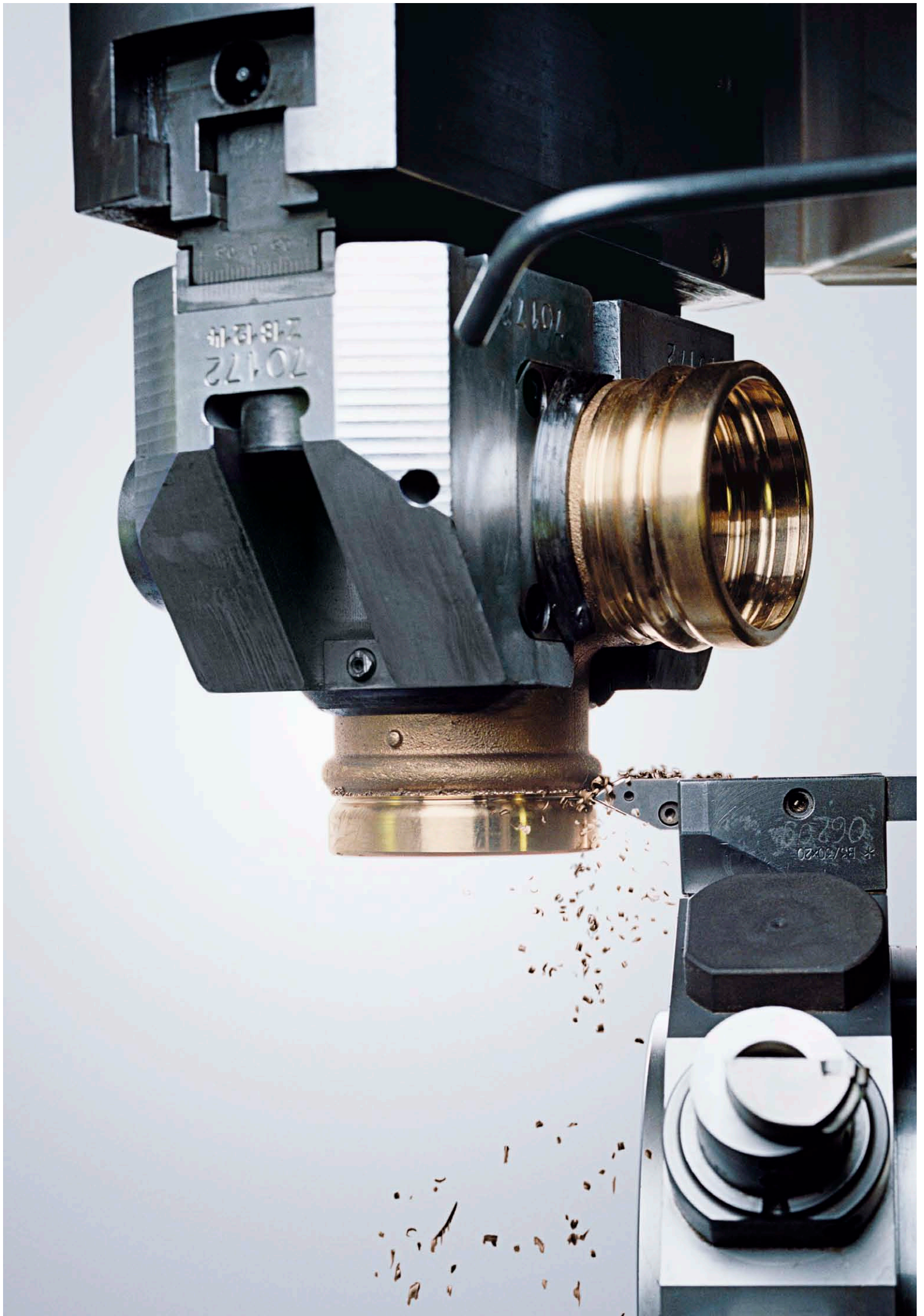



Viega.

CONNECTED IN QUALITY.

Viega is convinced: Quality is everything. Without quality, everything means nothing. That is why the company strives to exceed itself each and every day. By means of regular dialogue with its customers, by developing better products and service features and by an approach to the future that does not lose sight of its past.

Viega has been connected in quality for over 115 years. It all began with the vision of revolutionising installation technology. With over 4,000 employees and ten locations, we have progressed to become a global market leader in the installation technology sector while still remaining true to our principles and setting our own high standards.

It is of importance to Viega to support its customers in their daily work. To this end, it shares its knowledge with customers all over the world, matches materials, technology and comfort, takes time for quality management and invests in research and development. The result: a perfectly coordinated system providing customers fast and reliable access to over 17,000 products.

Quality is everything. Without quality, everything means nothing.

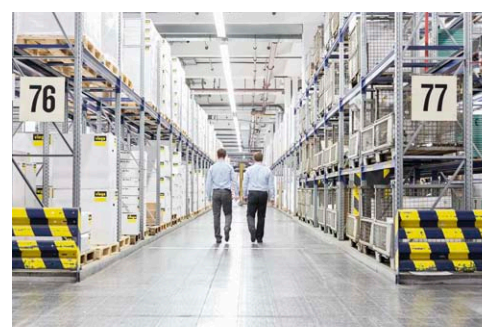

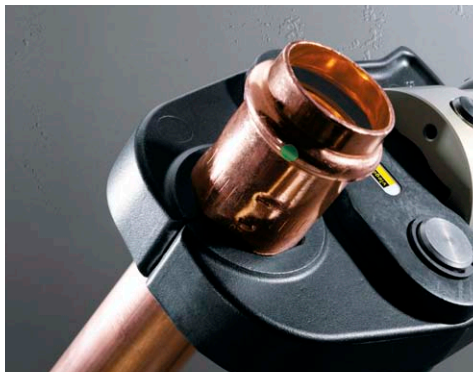

CONTENTS

6

Viega press technology: One tool to connect everything.



8

Viega press connectors: Guaranteed maximum safety.

10

Viega system landscape: Where everything fits in one place.

12

Viega competences: One standard for all media.

13

Viega systems: The right solution for every challenge.

27

Viega Pressguns: Maximum implementation reliability in two versions.



Viega press systems

VERSATILE OPTIONS FOR EVERY APPLICATION.

With a variety of various press systems made from different materials, Viega has the perfect system for every requirement – whether this involves drinking water, gas, heating, other applications in buildings, industrial plants or ships. It goes without saying that all the systems guarantee maximum safety, correspond with the country-specific standards and make no compromise in terms of “Quality made in Germany”.



Viega press technology

ONE TOOL TO CONNECT EVERYTHING.

Its extensive range of press connectors, numerous innovations in the area of cold pressings and a requirement to always produce top quality, has put Viega in the leading role in the press technology sector. This applies equally to drinking water, gas, heating or special applications.



Top quality – guaranteed

A decision for the press technology provided by Viega is a decision in favour of “Quality made in Germany”. By doing so, you receive the best the brand has to offer. Therefore, Viega is the market leader in metallic press systems. This is something rendered possible through exclusively in-house production, the particularly painstaking quality assurance and the company’s own goal of continuous development.

Easy to fit, always reliable

Press technology offers clear advantages. Aspects such as fire risk, comprehensive fire-protection precautions and the unsightly traces of fire and soldering are now things of the past. Press technology is not only much easier to use, but now it is absolutely reliable because of the cylindrical pipe guidance and the patented Viega SC-Contur. This means that additional qualifications such as, e.g. welding are no longer required. Press technology can be readily used by every specialised craftsman.

Quick and economical

Thanks to its quick processing capability, the cold press technology is far superior to other methods, including installation time. Depending on the system involved, tremendous time savings of up to 80% are possible. In practical terms, this enables, on the one hand, work to be conducted efficiently, while on the other hand, enabling more projects to be handled in the same period. The bottom line is that this is a great benefit for every installation.

Convenient and easy-to-use

With the Viega Pressguns, Viega offers a press tool that combines convenience and safety. The flexible and space-saving press rings with hinged adapter jaw enable work to be conducted more conveniently and quickly, even in narrow pipe shafts. The matching press rings make extensive installations in dimensions up to 108 mm in extremely economic one-man mounting processes.



Large dimensions can be easily pressed using the press ring.



ADVANTAGES AT A GLANCE

- One tool for all press systems
- Quick pressing for dimensions from 12 to 108 mm
- Time saving of up to 80%
- Economic one-man installation
- Simple processing without any additional qualification required
- No fire risk, no fire protection measures

Viega press connectors

GUARANTEED MAXIMUM SAFETY.

Viega's double-press "V-Contur" design delivered a great leap forward when launched and continues to be regarded as the state of the art for pipe connection technology. Together with Viega SC-Contur, Viega's press connectors provide security and reliability – in both pressed and unpressed states.



Double pressing – twice as good

Viega press technology is based on double pressing. In each pressing process, pressing is conducted both before and after the connector bead (Fig. 1) thereby guaranteeing a durable, torsion-resisting and a non-positive longitudinal connection.

SC-Contur – a small contour for maximum reliability

The patented SC-Contur from Viega by far the greatest boost to reliability in the sector of press technology. This safety feature ensures that any unintended unpressed connections are 100 % leaky – and therefore they are noticed immediately.

Product marking – no risk of confusion

Every press connector from Viega is uniquely marked. The colours for the markings are used to denote different service areas. A green mark for drinking water (Fig. 2), a yellow one for gas, white for solar, district heating and low pressure steam, blue is for labs-free connectors, red and black for “No drinking water”. Dimensions from 64 mm onwards have an orange label attached to them, which is then removed again after pressing.

Sealing elements – ranging from universal to special

Things are no different when choosing the correct elastomer material, here too, top quality is what counts at Viega. Only premium-quality sealing elements enable the requirement to operate pipe installations throughout the entire life cycle for a building without any malfunctions and maintenance. With only three different sealing elements, Viega has the perfect solution for each application (Fig. 3): EPDM primarily for drinking water and heating installations, hydrated acrylonitrile-butadiene rubber (HNBR) for gas, heating oil and diesel pipes as well as FKM for special applications in a higher temperature range.

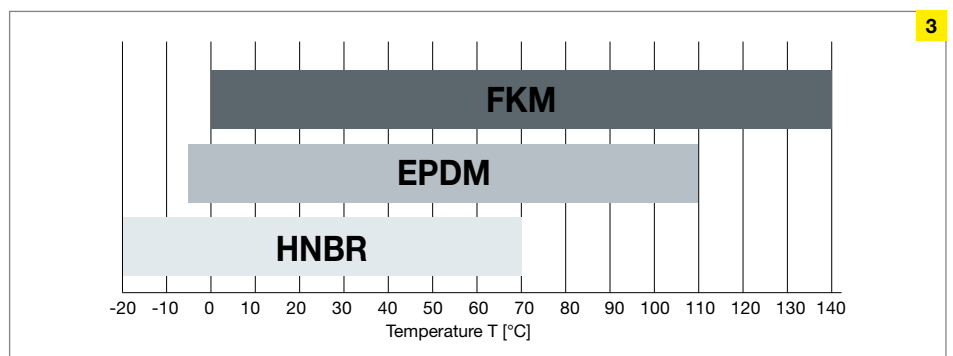
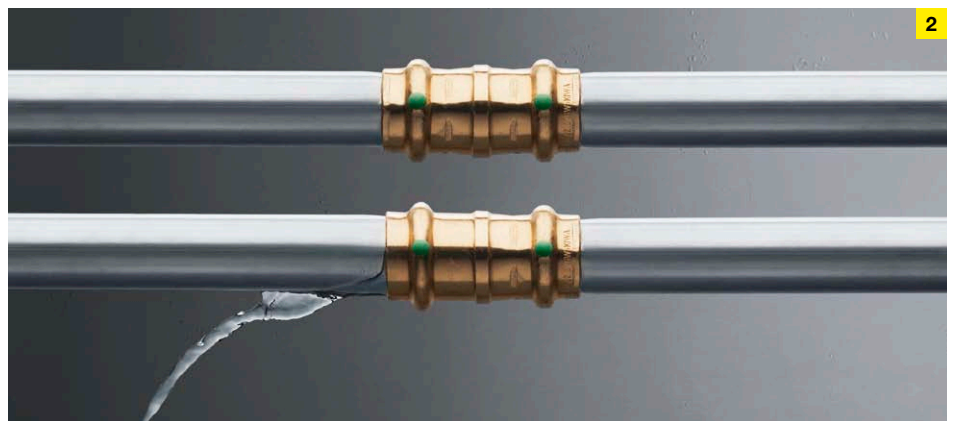
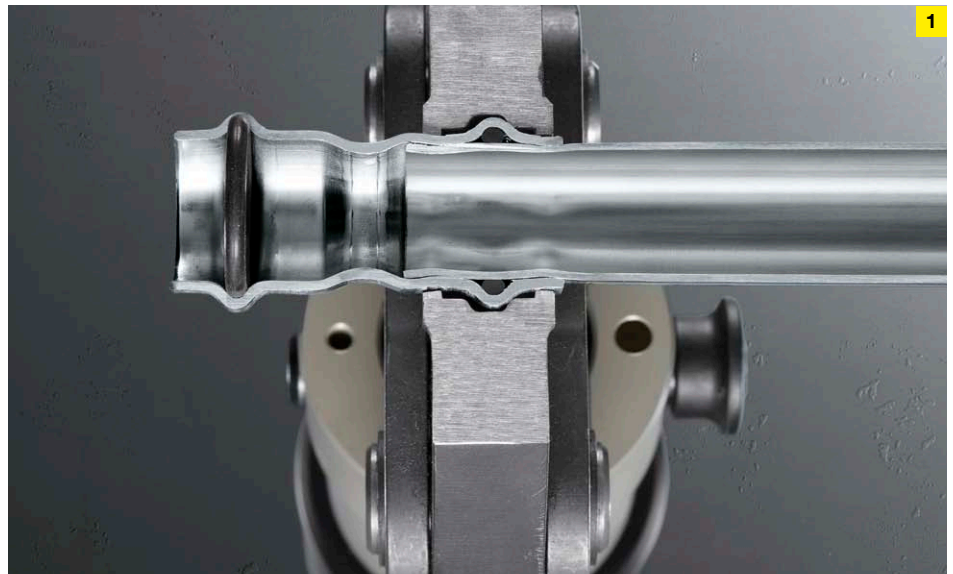

Temperature working ranges of the specific materials for sealing elements in Viega press connectors. Every elastomer material exhibits the properties required for each service area such as, the necessary chemical resistance as well as the characteristic temperature working range. Here, an operational lifetime of at least 50 years is a requirement, something also required in numerous regulations for building services engineering.



ADVANTAGES AT A GLANCE

- Maximum reliability through double pressing and SC-Contur
- Unique product marking rules out any risk of confusion
- Three high-quality sealing elements for all application cases



Viega system landscape

A LANDSCAPE WHERE EVERYTHING FITS PERFECTLY INTO PLACE.

The diverse range of requirements placed on installation and piping systems, are becoming increasingly more complicated. Exact planning and a detailed, well-thought-out system network in which everything fits perfectly into place, make the work so much simpler and installation easier.

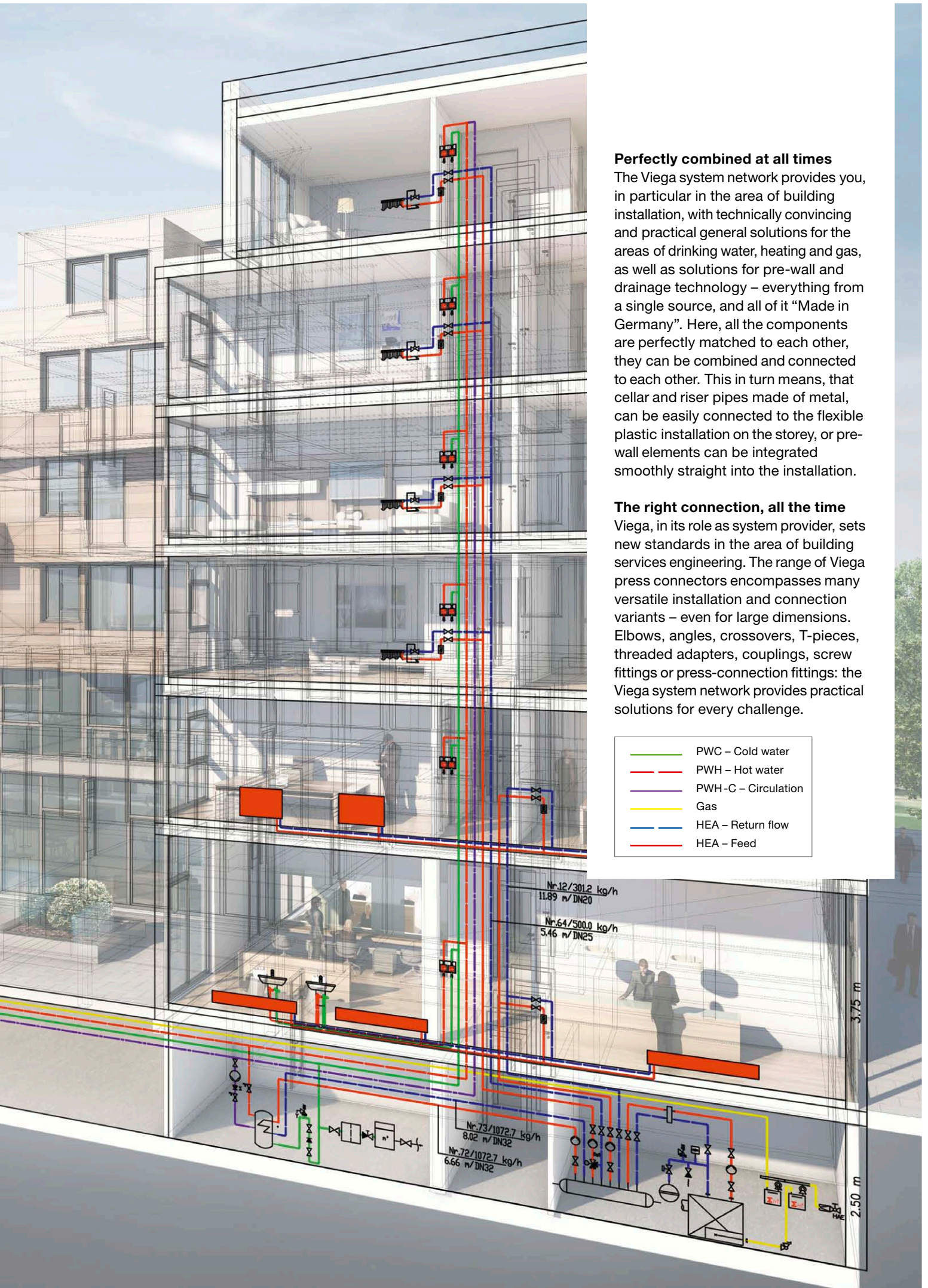

Perfectly combined at all times

The Viega system network provides you, in particular in the area of building installation, with technically convincing and practical general solutions for the areas of drinking water, heating and gas, as well as solutions for pre-wall and drainage technology – everything from a single source, and all of it “Made in Germany”. Here, all the components are perfectly matched to each other, they can be combined and connected to each other. This in turn means, that cellar and riser pipes made of metal, can be easily connected to the flexible plastic installation on the storey, or pre-wall elements can be integrated smoothly straight into the installation.

The right connection, all the time

Viega, in its role as system provider, sets new standards in the area of building services engineering. The range of Viega press connectors encompasses many versatile installation and connection variants – even for large dimensions. Elbows, angles, crossovers, T-pieces, threaded adapters, couplings, screw fittings or press-connection fittings: the Viega system network provides practical solutions for every challenge.

- PWC – Cold water
- PWH – Hot water
- PWH-C – Circulation
- Gas
- HEA – Return flow
- HEA – Feed

Nr.12/301.2 kg/h
11.89 m/DN20

Nr.64/500.0 kg/h
5.46 m/DN25

Nr.73/1072.7 kg/h
8.02 m/DN32

Nr.72/1072.7 kg/h
6.66 m/DN32

3.75 m

2.50 m

Viega competences

ONE STANDARD FOR ALL MEDIA.

This applies equally to drinking water, gas, heating or special applications: Every system from Viega combines the finest in material quality with pioneering safety and enormous efficiency. Every individual system is being continuously developed and improved, to ensure that along with the legal standards and regulations for drinking water quality or safety with gas installations, the ever-more stringent requirements placed on the trade can also be met.



Drinking water

Maintaining drinking water quality is a matter of prime importance to Viega. Numerous systems with optimised pressure-loss components and cross-system special components such as double wall panels, forcing plugs or the Smartloop inliner technology provide hygienic solutions for every possible challenge. The easy installation of ring and series pipelines, the use of flushing stations to prevent stagnation as well as the dry leakage test help to meet the most-stringent standards and regulations.



Heating

More than ever, in the area of heating engineering, everything comes down to efficiency – this also applies to assembly. Viega systems and cross-system special components such as cross T-pieces, crossovers, radiator connection blocks or skirting board radiator connection pieces comply with this requirement – and this includes in the industrial and special application areas.



Gas

Utmost safety always has top priority where gas supply lines are involved. With Profipress G, Viega has launched a press system for gas installations onto the market. Cold pressing completely rules out any risk of fire or explosion during assembly. Numerous special components such as, for example, the gas ball valve are all part of the large product range.



Special applications

Many of the Viega press systems are also ideally suited for special applications, for example, for industry or shipbuilding. Details on the application area as well as on the operating temperature and pressure are available in each of the technical documents.

Viega systems

THE RIGHT SOLUTION FOR EVERY CHALLENGE.

14
Viega Profipress 

20
Viega Megapress 

15
Viega Profipress G 

21
Viega Megapress G 

16
Viega Profipress S 

22
Viega Prestabo 

17
Viega Sanpress Inox 

23
Viega Smartpress 

18
Viega Sanpress Inox G 

24
Viega Easytop 

19
Viega Sanpress 

27
Viega Pressguns



Viega Profipress

ONE PRESS CONNECTOR SYSTEM, ALL POSSIBLE OPTIONS.

Profipress is a copper connector system that has been tried-and-tested a million times over, and which can be used for almost every application area. In combination with Profipress G and Profipress S, it provides a range of more than 800 articles which makes it a comprehensive solution in the area of installation technology. Top "Quality made in Germany" applies here to each and every detail – from the cylindrical pipe guidance to the high-quality sealing element.

Applications

Profipress unites maximum safety with the greatest possible level of versatility – the application options here are almost unlimited. After all, with more than 800 individual articles, the system covers the entire installation range. This is regardless of whether drinking water, heating, any other application in buildings, industrial plants or pipelines in ships are involved.

Material

With Profipress, Viega is systematically counting on copper and gunmetal. Both materials enable hygienic installation along with maximum reliability in terms of material quality, absolute dimensional stability and a long service life. The connectors are also all equipped with a high-quality EPDM sealing element.

Additional information

The complete system is equipped in every dimension with SC-Contur, which enables inadvertently unpressed connections to be clearly recognised when performing a leakage test.

Dimensions

The high product mix depth, the various components and solutions for every possible application are available in dimensions ranging from 12 to 108 mm – naturally, this also includes the intermediate size of 67 mm.



Profipress connectors for drinking water installations can be recognised by the green dot. All connectors are made of copper and gunmetal, and they are equipped with an EPDM sealing element.



ADVANTAGES AT A GLANCE

- Extensive product mix depth including special components for any kind of installation
- Suitable for drinking water and heating installations as well as any other applications in buildings and even in ships
- Made of copper and gunmetal for maximum quality, dimensional stability and service life
- Available in dimensions 12 to 108 mm including intermediate size 67 mm
- All dimensions come with the SC-Contur
- Equipped with high-quality EPDM sealing element



Viega Profipress G

MAXIMUM SAFETY FOR GAS SUPPLY LINES.

The Profipress G press connector system offers safety at the highest level. The system is ideally designed for the routing of gas supply lines and certified in accordance with the stringent German specifications pertaining to almost all installations involving combustible media.

Applications

Profipress G is used wherever no compromises can be made with safety. With top quality material and intelligent safety details, it is certified for gas installations as well as for heating oil and diesel pipes.

Material

With Profipress G, Viega is counting on high quality connectors made of copper and gunmetal, that when used in combination with the yellow HNBR sealing element guarantee maximum safety, dimensional stability and long service life.

Dimensions

Profipress G provides a system diversity ranging from 12 to 64 mm. Screw fittings, flanges for gas fittings with press connection and meter connection units with connectors for direct pressing of gas supply lines are only a small section of the product range.

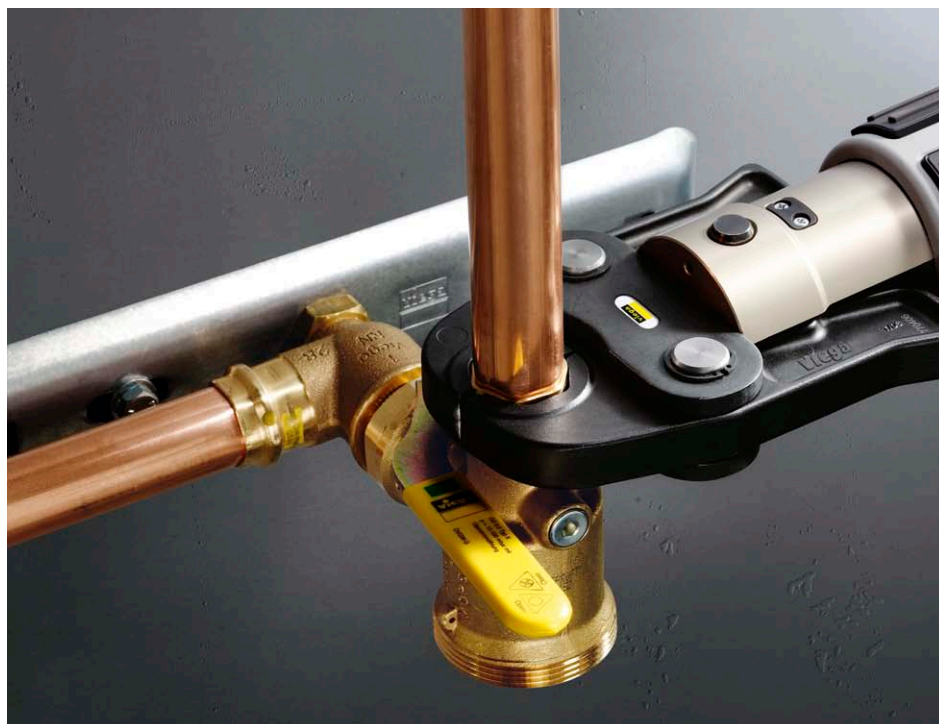

Profipress G connectors are marked with a yellow rectangle, to help avoid any confusion.

Additional information

The complete system is equipped in every dimension with SC-Contur, which enables inadvertently unpressed connections to be clearly recognised when performing a leakage test. All connectors are also marked with a yellow rectangle to avoid any confusion.



ADVANTAGES AT A GLANCE

- Suitable for gas installations as well as for heating oil and diesel pipes
- Made of copper and gunmetal with high quality HNBR sealing element
- All dimensions come with SC-Contur and they are marked with a yellow rectangle for clear differentiation
- Available in dimensions 12 to 64 mm



Viega Profipress S

SPECIFICALLY DEVELOPED FOR SPECIAL APPLICATIONS.

Profipress S is always the right choice whenever a reliable press connecting system is required for special applications. With first-quality material and maximum precision, Profipress S makes perfect connections between the various heat sources.

Applications

Profipress S provides safe connections at high temperature as, e.g. in solar or low pressure steam systems. The connectors are approved for use in low pressure steam systems up to a temperature of 120 °C and a pressure of 1 bar. For district heating systems, the maximum operating temperature is 140 °C and the maximum operating pressure is 16 bar.

Material

With Profipress S, Viega is systematically counting on copper and gunmetal. The system is equipped with an FKM sealing element. For dimensions greater than 35 mm, Profipress connectors can also be retrofitted with an FKM sealing element.

Dimensions

Profipress S is available in dimensions from 12 to 35 mm with a factory-fitted FKM sealing element. For dimensions from 42 to 108 mm, Profipress connectors can also be used with an FKM sealing element.

Additional information

All connectors come with the SC-Contur. For greater differentiation, the connectors are packed in an orange-coloured plastic bag and marked with a white rectangle – that refers to the FKM sealing element.

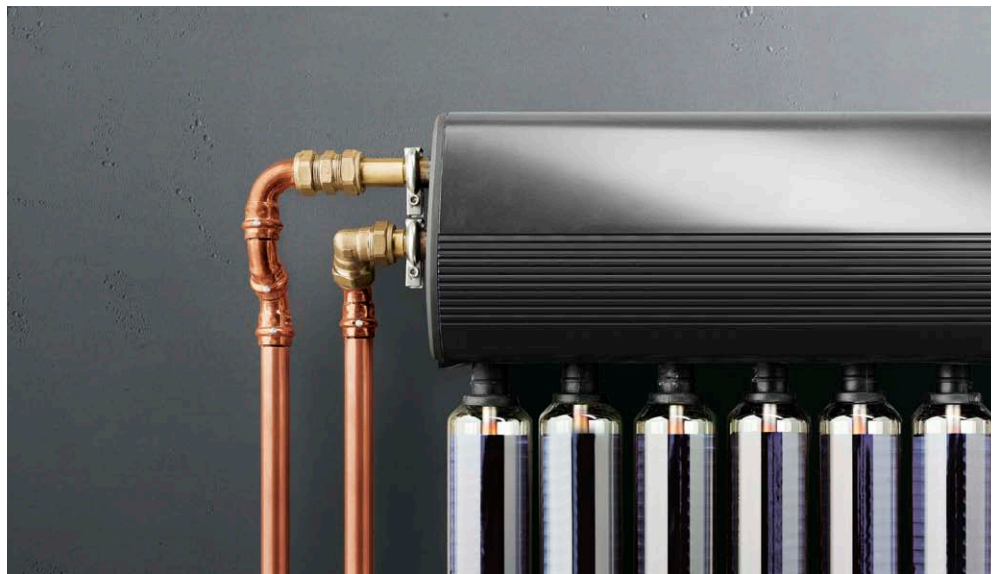

Profipress S on a thermal solar installation with vacuum pipe connectors.

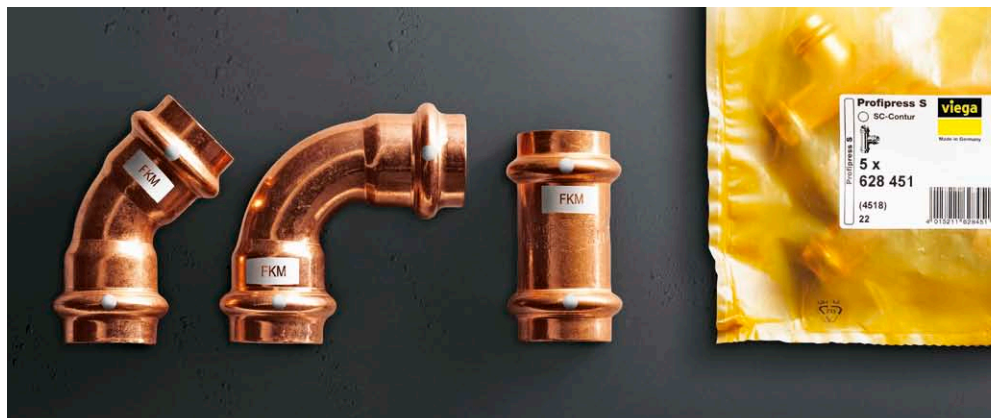

All connectors up to 35 mm are marked with white dots and a white FKM marking.



ADVANTAGES AT A GLANCE

- Perfectly suited for all special applications such as solar installations, district heating installations and low pressure steam installations
- Made of copper and gunmetal with high quality FKM sealing element
- Available in dimensions 12 to 108 mm
- All dimensions come with the SC-Contur
- Any confusion is ruled out through an orange-coloured plastic bag and white marking on connectors



Viega Sanpress Inox

A STAINLESS STEEL SYSTEM FOR TOP QUALITY DRINKING WATER INSTALLATIONS.

A reliable system made of high quality materials. The pipe materials 1.4521 and 1.4401 are combined in Sanpress Inox with press connectors made of stainless steel. This creates a system that meets even the most stringent conditions in the drinking water installation area.

Applications

Irrespective of how high the requirements for the preservation and constancy of drinking water quality are: Sanpress Inox fulfils even the most stringent of guidelines. It is therefore not only perfectly suited for drinking water installations, but also for industrial cooling and process water systems.

Material

Sanpress Inox is made all the way through of high-quality, stainless steel. The stainless steel press connectors are equipped with an extremely durable EPDM sealing element. The matching stainless steel pipes 1.4521 and 1.4401 are perfectly hygienic and excel on account of their efficiency.

Dimensions

The stainless steel system is available in dimensions from 15 to 108 mm, and with its numerous elbows, crossovers, angle sections, sleeves, screw fittings and fittings it has a matching solution for every application area.

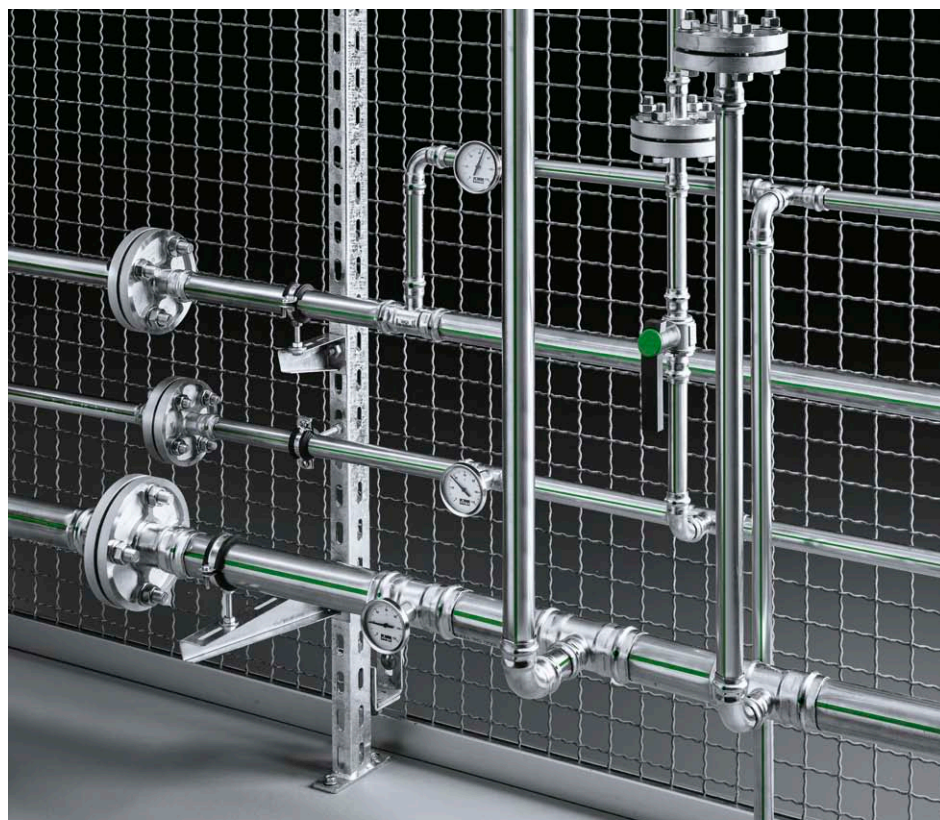

The comprehensive product range provides a matching solution for every application area.

Additional information

The press connectors are available in all dimensions with the patented SC-Contur, which enables inadvertently unpressed connections to be recognised when performing a leakage test.



ADVANTAGES AT A GLANCE

- Can be used for all types of drinking water
- Top quality material all the way through, created by a combination of stainless steel connectors with stainless steel pipes 1.4521 and 1.4401
- Available in dimensions 15 to 108 mm
- All connectors come with SC-Contur
- High quality, durable EPDM sealing element



Viega Sanpress Inox G

A STAINLESS STEEL SYSTEM FOR TOP QUALITY GAS INSTALLATIONS.

Absolute safety is always top priority for every gas installation. The stainless steel system Sanpress Inox G, was specially developed for areas in which material and technology are exposed to maximum stresses.



Applications

Sanpress Inox G is used wherever no compromises can be made in terms of safety. With first-quality material and intelligent safety details, it is certified for all types of gas installations as well as for heating oil and diesel pipes.

Material

Sanpress Inox G press connectors are made all the way through of high-quality, stainless steel. These are combined with pipes made of material 1.4401. The stainless steel press connectors are also equipped with a durable HNBR sealing element.

Dimensions

The stainless steel system in dimensions from 15 to 108 mm is designed for use in gas installations. In addition to this, the dimensions from 15 to 54 mm can be used with heating oil and diesel fuels.

Additional information

The connectors are all equipped with a yellow sealing element and uniquely identified with yellow markings. The press connectors are available in all dimensions with the patented SC-Contur, which enables inadvertently unpressed connections to be recognised when performing a leakage test.



The yellow marking refers to the HNBR sealing element and rules out any confusion.



ADVANTAGES AT A GLANCE

- Suitable for gas installations as well as for heating oil and diesel pipes
- Top quality material all the way through, created by a combination of stainless steel connectors and a pipe made of material 1.4401
- High quality, durable HNBR sealing element
- All connectors come with SC-Contur
- Dimensions 15 to 108 mm (gas and liquid gas in gas phase)
Dimensions 15 to 54 mm (also for heating oil and diesel fuels)



Viega Sanpress

QUALITY AND EFFICIENCY FOR DRINKING WATER INSTALLATIONS.

This applies equally to drinking water installations, industry or plant engineering: Sanpress sets new standards in terms of quality and efficiency. The enormous product diversity ensures that even particularly demanding installations can be easily implemented.



Applications

Sanpress is the efficient solution for all types of drinking water installations. All components in the system are checked and certified. Sanpress guarantees hereby long-term safety in terms of the preservation and constancy of drinking water quality in drinking water and industry installations.

Material

The system consists of high strength, durable gunmetal connectors as well as the efficient stainless steel pipes 1.4521 and 1.4401.

Dimensions

The individual components are available in dimensions 12 to 108 mm. Particularly low Z dimensions help to make installation easier.

Additional information

With the Viega Sanpress double wall panel and the Sanpress wall plate T-piece, nothing now stands in the way of hygienically optimised pipeline routing such as, e.g. a ring or series pipeline. It goes without saying that all connectors are equipped with SC-Contur for even greater safety during installation.



The Sanpress product range encompasses all the components required for a drinking water installation.



ADVANTAGES AT A GLANCE

- Can be used for all types of drinking water
- High-strength gunmetal connectors with low Z dimensions as well as stainless steel pipes 1.4521 and 1.4401
- All connectors come with SC-Contur
- All components required for proper hygienic drinking water installations
- Space, material and time saving installation through Sanpress compensators



Viega Megapress

FAST AND RELIABLE COLD PRESSING OF THICK- WALLED STEEL PIPES.

Megapress saves you a lot of welding work. This is because, at long last, thick-walled steel pipes can now be pressed easily, safely and efficiently. This is up to 60% faster with dimensions between $\frac{3}{8}$ and 2 inches, and up to 80% faster with dimensions between $2\frac{1}{2}$ and 4 inches. Reliability is guaranteed by SC-Contur.

Service areas

Megapress is used for black, galvanised, industrially painted or epoxy-resin coated steel pipes. Megapress makes complex threaded adapters or strenuous welding for new installations and refurbishments of heating installations superfluous. Thanks to its zinc-nickel coating, it is also suitable for use in cooling systems or industrial plant engineering.

Material

The Megapress connectors are made of pipe-formed steel 1.0308 and come with a high-quality zinc-nickel coating. In dimensions of up to 2 inches, they have an EPDM profile sealing element; XL dimensions have an FKM round sealing element. This guarantees maximum safety, robustness and durability for every installation.

Dimensions

Megapress is available in dimensions $\frac{3}{8}$ to 4 inches and therefore it can be used universally.

Additional information

Pipes and connectors are labelled with a black symbol "not drinking water". Every available Megapress dimension comes with the SC-Contur, which enables inadvertently unpressed connections to be recognised immediately when performing a leakage test.



Megapress in a heating installation with energy buffering.



ADVANTAGES AT A GLANCE

- In terms of economy, up to 60 % less installation time for connection compared with welding for sizes from $\frac{3}{8}$ to 2 inches, and up to 80 % for sizes from $2\frac{1}{2}$ to 4 inches.
- Press connector system for thick-walled steel pipes in threaded pipe and boiler pipe qualities.
- For universal use. Presses thick-walled steel pipes with nominal connection diameters from $\frac{3}{8}$ to 4 inches, regardless whether the pipe is seamless, welded, black, galvanised or epoxy resin coated.
- With time-proven Viega SC-Contur in all Megapress connectors.



Viega Megapress G can be used in a multitude of applications NOW PUTS AN END TO WELDING WORK IN GAS INSTALLATION TOO.

Safety comes first when gas is concerned. Therefore thick-walled steel pipes are ideally suited for industrial gas installations – and can now also be cold pressed using Viega Megapress G. They are not only a reliable choice that way but now are even particularly economical thanks to Viega Megapress G.

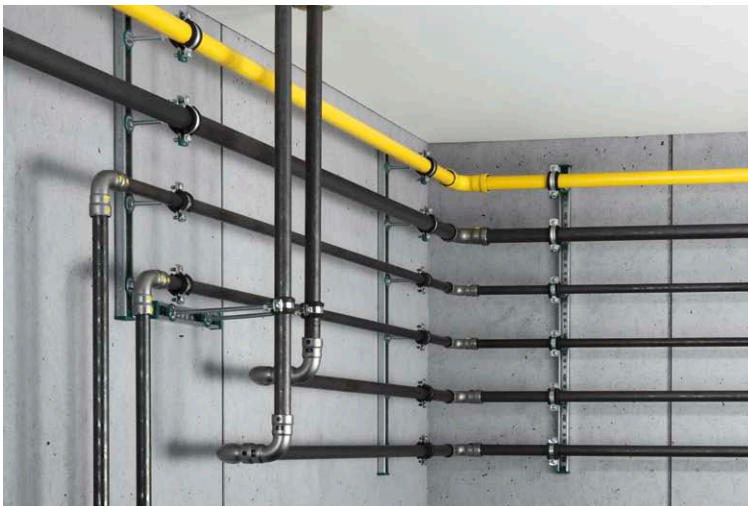

Areas of application

Viega Megapress G covers a broad installation spectrum with a large number of new components such as elbows, sleeves, T-pieces, flanges, threaded adapters and screwed connections in sizes from ½ to 2 inches. The system is approved both for natural and liquid gases according to DVGW Worksheet G 260 and for installation systems according to DVGW-TRGI 2008 and TRF 2012. The system is also suitable for media such as fuel oil, diesel, compressed air, as well as for use in industrial systems. In addition, Viega Megapress G has higher thermal resistance and is approved for up to the maximum operating pressure of 5 bar (MOP 5). Ideal preconditions for reliable gas installations.

Material

The Megapress connectors are made of recast pipe steel 1.0308, they have a zinc-nickel coating and they come with a profile sealing element made of high quality HNBR. The technical specifications of the material are adapted

for use in gas installations as well as fuel oil and diesel fuel systems. This guarantees maximum safety, robustness and durability for every installation.

Dimensions

Megapress is available in ½ to 2 inch sizes, meaning it can be universally used.

Additional information

Each connector has a clear yellow label indicating its use for gas. This rules out the possibility of mixing up or accidental incorrect use of Viega Megapress G.



REASONS FOR VIEGA MEGAPRESS G

- Suitable for natural and liquid gases according to DVGW Worksheet G 260 and for fuel oil and diesel fuel systems
- Economical thanks to up to 60 % less installation time when compared with welding with regard to the connection method
- Highly economical thanks to major time saving on installation
- Absolutely fire-safe, because neither flames nor fumes arise with cold press technology
- No additional time and cost expenditure for fire protection precautions.
- Safety thanks to the Viega SC-Contur
- Presses thick-walled steel pipes with nominal connection diameters from ½ to 2 inches, irrespective of whether the pipe is seamless, welded, black, galvanised or epoxy resin coated



Viega Prestabo

GALVANIZED STEEL FOR OUTSTANDING EFFICIENCY.

Reliable, safe, galvanized: three of the properties so highly estimated by experts. The enormous product range, the intelligent safety solutions and the outstanding efficiency make the decision to choose Prestabo an even easier one.

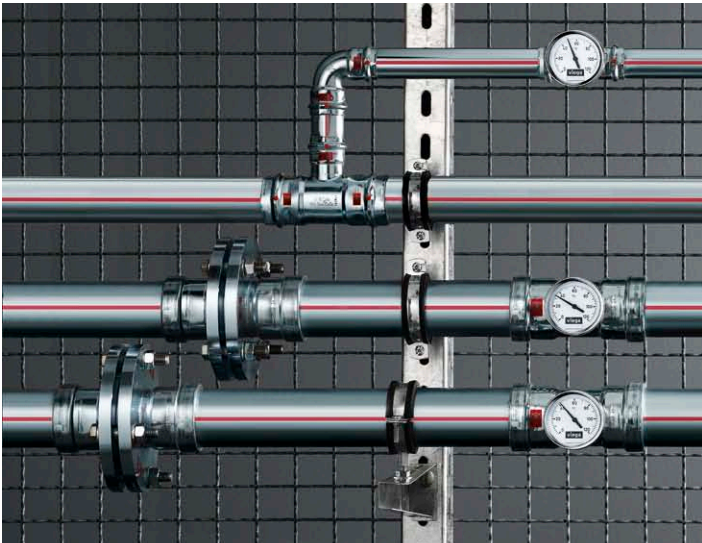

Applications

The Prestabo press connection system is the efficient alternative for all heating installations, closed cooling circuits and compressed air systems.

Material

With galvanized steel, Prestabo combines a material tried-and-tested in the market with the advantages of cold pressing technology. As an externally galvanized variant, the system is suitable for heating and industrial plants. With an additional plastic sheath, it is ideal for wall-mounted installations. As an externally and internally galvanized variant, it also provides corrosion protection when used in sprinkler and compressed air systems.

Dimensions

The comprehensive product range for Prestabo includes press connectors and pipes in dimensions from 12 to 108 mm.

Additional information

All Prestabo connectors come with SC-Contur. The Prestabo pipes are available for wall-mounted installations, also with PP sheathing. Both the connectors as well as the pipes are marked with a red "No drinking water" symbol.



A practice-oriented complete system in dimensions 12 to 108 mm.



ADVANTAGES AT A GLANCE

- An efficient system for closed heating installations, closed cooling circuits and compressed air systems
- Non-alloy steel 1.0308 in three variants: externally galvanized, externally galvanized and PP sheathed, externally and internally galvanized
- In dimensions 12 to 108 mm
- All connectors come with SC-Contur
- Pipes and connectors all have a red "No drinking water" message



Viega Smartpress

ADVANCED MULTILAYER SYSTEM WITH MINIMAL PRESSURE LOSS

Viega Smartpress is the next major step in flexible floor installation. The innovative press connector system combines know-how gathered over many years, tried-and-tested technology and high-quality, corrosion resistant and durable materials in a single connector. It furthermore combines speedy processing and minimum pressure losses to ensure safe and economically efficient drinking water and heating installations.



Service areas

Viega Smartpress connectors can be used in drinking water and in heating installations. With its minimum pressure losses, the system is perfectly suited for ring, series, and T-piece installation.

Material

Consistently flow-optimised, the stainless steel and gunmetal connectors are perfectly hygienic and allow for smaller dimensioning of the drinking water installation thanks to their optimum part geometry. The product portfolio is complemented by an extensive range of dimensionally stable plastic piping systems.

Dimensions

Viega Smartpress is available in different versions in dimensions 16 to 63 mm.

Additional information

Viega Smartpress comes with the SC-Contur, which enables inadvertently unpressed connections to be immediately recognised when performing a leakage test.



REASONS FOR VIEGA MEGAPRESS G

- Elbows, couplings and T-pieces made of stainless steel, threaded connectors made of gunmetal
- One single connector for drinking water and heating installations
- Flow-optimised internal geometry and minimal narrowing of cross-sections allow for smaller dimensions
- Corrosion resistant connectors in dimensions from 16 to 63 mm
- Connector technology without any O-rings
- Calibration not needed – up to 30% faster
- Compatible with pipes from Viega Pexfit Pro and Viega Pexfit Fosta systems
- Excellent flexural properties with high buckling resistance
- Pressing also possible with Viega Smartpress press rings



Viega Easytop slanted seat valves

FOR ALL MATERIALS, SIZES, TYPES OF CONNECTIONS – AND REQUIREMENTS.

The Easytop slanted seat valve is available as a slanted seat valve, combined slanted seat valve with backflow preventer and as a backflow preventer alone – available of gunmetal or silicon bronze with dimensions DN 15 to DN 100 or stainless steel with the dimensions DN 15 to DN 50. All variants come with corrosion-resistant valve disc units of high-quality stainless steel and a new innovative sealing concept.



Technical details

Made of corrosion-resistant stainless steel, the full functionality of all Easytop system fittings is ensured at all times. The completely novel, innovative sealing concept of the system valves furthermore protects the valve plate seal from damage caused by excessive pressing forces.

Hands-on benefits

The ergonomically designed hand-wheels are easier to grip; thanks to the non-rising valve stem, they are easy to install also in confined installation situations. The signal colour of the position indicator clearly shows whether the valve is open or closed, even seen from a distance.

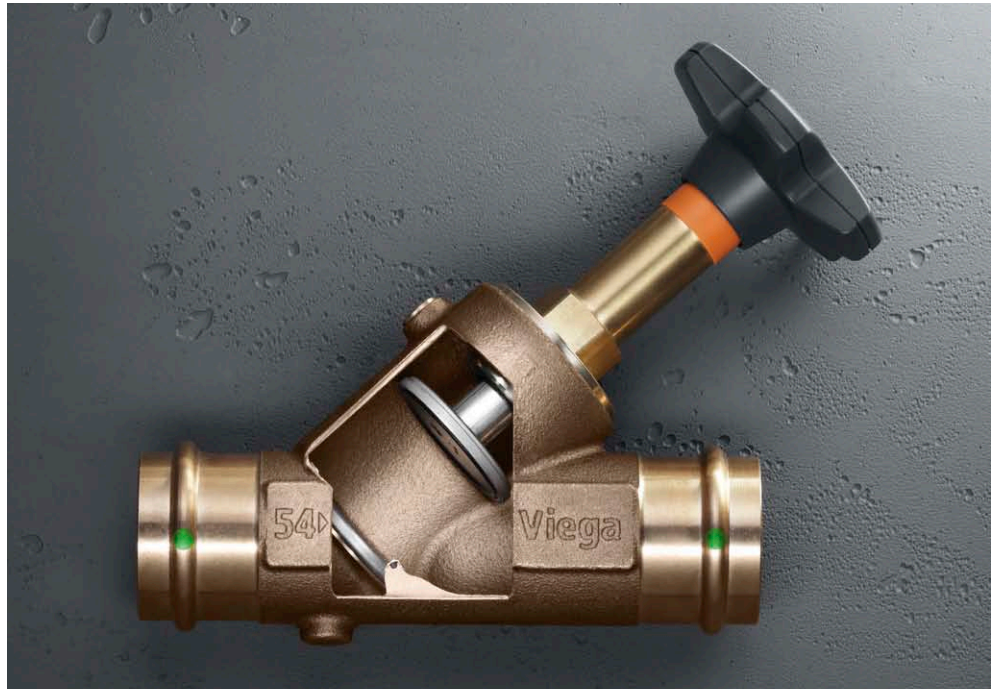

Time-tested variants are still in the portfolio

Whether stainless steel, gunmetal or silicon bronze: The broad product range with different variants meets all requirements and caters for all installation preferences – for the fans of instant pressing just as for those who prefer

conventional screwed connections. The Easytop system fittings offer a wide choice of accessories such as insulating shells, drainage valves and extensions as well as pressure loss optimisation. It goes without saying that they meet all national and international standards and regulations.



ADVANTAGES AT A GLANCE

- Can be used for all types of drinking water
- Use of high-quality materials such as stainless steel, gunmetal and silicon bronze
- System press connections for Viega piping systems
- Innovative sealing concept using the principle of secondary force connection
- Valve seat and valve disc unit of stainless steel
- Insulating shell of EPP as accessories for all dimensions

Viega Easytop system ball valves

DEPENDABILITY FOR ALL APPLICATIONS.

Whether made of high-quality gunmetal or silicon bronze or long-lived stainless steel, all system ball valves have a stainless steel shut-off unit and are suitable for all drinking water and heating installations as well as for industrial and plant engineering. Equipped with the patented SC-Contur, the Viega Easytop system ball valves with direct press connection guarantee premium safety even during mounting.



Well thought out handling

With its ergonomic design, the new T-shaped actuating lever not only provides for easier, more comfortable operation of the ball valve but also saves valuable space. Furthermore, the actuating handle offers the possibility of integrating a thermometer directly into the installation – without any additional effort.

Premium technology

State-of-the-art manufacturing technologies and most recent machines guarantee top quality. The actual actuating torques, for example, are significantly better than those specified in DIN EN 13828. Future-safe materials with a long service life and a sealing concept adjusted to the casing and the shut-off unit provide for optimum functional safety, even under the most extreme conditions.

Fit for unlimited use

Easytop system ball valves are extremely versatile. They can be used for example as simple maintenance fittings, or to shut off individual devices, riser pipes, or entire storey connection pipes. Easytop ball valves are even suitable for industrial and plant engineering purposes, for example process plants operated with nitrogen, argon, or under

vacuum. The delivery includes differently coloured plastic caps as media markings for the actuating lever to give a perfect overview over the wide range of applications. They allow you to identify hot water, cold water, or special media at a glance.



ADVANTAGES AT A GLANCE

- Suitable for drinking water and heating installations
- Use of high-quality materials such as stainless steel, gunmetal or silicon bronze
- Shut-off unit made of stainless steel
- Insulating shell of EPP as accessories for all dimensions
- System press connections for Viega piping systems
- New models with drainage option
- Thermometer as accessories set for the new T-shaped actuating lever



Viega Easytop circulation regulation valve

ONE VALVE WITH TWO FUNCTIONS.

The Easytop circulation regulation valve of gunmetal is suitable for being used with all types of drinking water. In all Viega installation systems, it is integrated in the installation quickly and safely using press connections for 15, 18, or 22 mm certainly equipped with the integrated reliable SC-Contur or screw fittings in G $\frac{3}{4}$ and G1 for plastic piping systems.



In hot water circulation pipes, the Easytop circulation regulation valve S/E helps to provide constant water temperatures at every extraction point. It opens and closes automatically to regulate the flow volume depending on the water temperature in the circulation pipe. Made of gunmetal, the circulation regulation valve can be used with all types of drinking water. In all Viega installation systems, it is integrated in the installation quickly and safely using press connections for 15, 18, or 22 mm or screw fittings in G $\frac{3}{4}$ and G1 for plastic piping systems.

Flexible properties

The control unit of the circulation regulation valve is equipped with a flexible-material element which reacts to temperature changes of the hot water in the circulation circuit. If the set value differs from the actual temperature, the flowthrough volume is changed by means of the valve lift to regulate the water temperature.

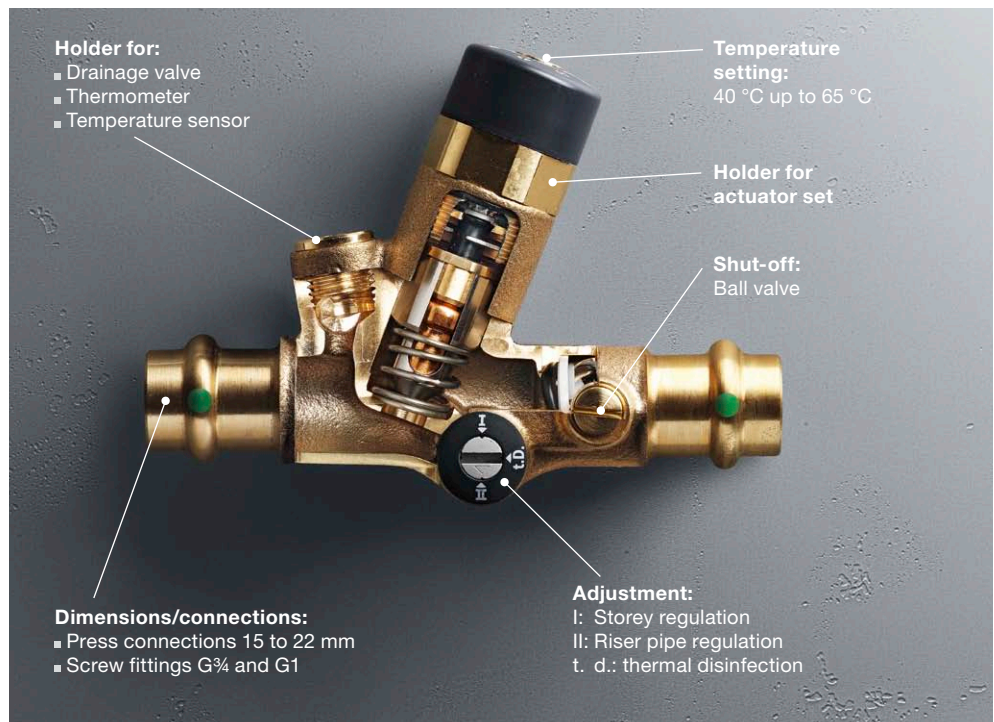

Fit for all types of applications

Installation is possible in both the riser pipe and on storey level. Installation on storey level is made in connection with a static circulation regulation valve in the riser pipe. Via the operating mode selection, the installation situation in riser pipe or on the storey can be

defined, and manual thermal disinfection can be set. At the control unit, the temperature can be infinitely adjusted from 40 °C to 65 °C in a simple process.



ADVANTAGES AT A GLANCE

- Can be used for all types of drinking water
- Use of high-quality gunmetal material
- System press connections for metal Viega piping systems
- Usable as riser or storey valve
- Integrated shut-off
- Can be integrated in a building automation system with accessories
- Insulating shell of EPP as accessories for all dimensions



Viega Pressguns

PREMIUM PERFORMANCE AND SAFETY.



Viega press jaws and press rings.



Press technology accessories in practical set case for Viega Pressgun 5.



Pressgun Press Booster Innovative force amplifier for Megapress XL with integrated hinged adapter jaw for sizes 2½, 3 and 4 inches

Both Viega Pressgun 5 and the Viega Pressgun Picco excel with maximum quality and this enables an easy and safe installation, even under the toughest of conditions. With their German Technical Inspection Agency (TÜV) certification and extremely long servicing intervals, they are among the most reliable, efficient and thereby most successful press tools in Europe.

Commonalities

- Easy operation with one hand through ergonomic gun shape
- Optionally available with mains operation, with the latest generation 18 V/2.0 Ah or 4.0 Ah lithium ion rechargeable battery, with optimised cold-start function and an exhaustive-discharge protection device
- Rotatable through 180° press head and hinged adapter jaws with press rings including hinged function, make it so much easier to access difficult to reach areas
- German Technical Inspection Agency (TÜV) approved safety technology: delayed actuation, pin retainer and maintenance display



SPECIAL FEATURES OF VIEGA PRESSGUN 5

- For metal piping systems of sizes 12 to 108 mm, for Megapress steel pipe connectors of ½ to 4 inches, for plastic piping systems from 12 to 63 mm
- Only 3.2 kg weight (without press jaw)
- Long maintenance intervals: after 40,000 pressings or 4 years
- Automatic safety lock after 42,000 pressings



SPECIAL FEATURES OF VIEGA PRESSGUN PICCO

- For metal piping systems of sizes 12 to 35 mm, for Megapress steel pipe connectors of ⅜, ½ and ¾ inches, for plastic piping systems from 12 to 40 mm
- Only 2.5 kg weight (without press jaw)
- Extremely small dimensions for mounting in confined pipe shafts and pre-wall installations
- Service only after 30,000 pressings or 4 years safety lock after 32,000 pressings

INT 769 413-1017-117690 · We reserve the right to effect changes.



Viega Holding GmbH & Co. KG

Viega Platz 1
57439 Attendorn
Germany

Phone +49 (0) 2722 61-0

viega.com

